

IIDWay Technology Co. Ltd

PRODUCT SPECIFICATIONS

For Customer: _____

: APPROVAL FOR SPECIFICATION

Customer Model No. _____

: APPROVAL FOR SAMPLE

Module No.: GZ70129-DIT055HD

Date : 2024-4-23

Table of Contents

No.	Item	Page
1	Cover Sheet(Table of Contents)	P1
2	Revision Record	P2
3	General Specifications	P3
4	Outline Drawing	P4
5	Absolute Maximum Ratings	P5
6	Electrical Specifications and Instruction Code	P6-P8
7	Optical Characteristics	P9-P12
8	Reliability Test Items and Criteria	P13
9	Precautions for Use of LCD Modules	P14-P15

For Customer's Acceptance:

Approved By	Comment

PREPARED	CHECKED	VERIFIED BY QA DEPT	VERIFIED BY R&D DEPT
YZJ			

IIDWay Technology Co. Ltd

3. General Specifications

GZ70129-DIT055HD is a TFT-LCD module. It is composed of a TFT-LCD panel, driver IC, FPC and a back light unit. The 5.5" display area contains 720 x 1280 pixels and can display up to 16.7M colors. This product accords with RoHS environmental criterion.

Item	Contents	Unit	Note
LCD Type	TFT	-	
Display color	16.7M		
Viewing Direction	ALL	O'Clock	
Operating temperature	-20~+70	°C	
Storage temperature	-30~+80	°C	
Module size	Refer to outline drawing	mm	
Active Area(W×H)	68.04X120.96	mm	
Number of Dots	720x1280	dots	
Controller	ILI9881D	-	
Power Supply Voltage	2.8	V	
Outline Dimensions	Refer to outline drawing	-	
Backlight	7S2P-LEDs (white)	pcs	
Weight	---	g	
Interface	MIPI Interface	-	

4.Outline.Drawing

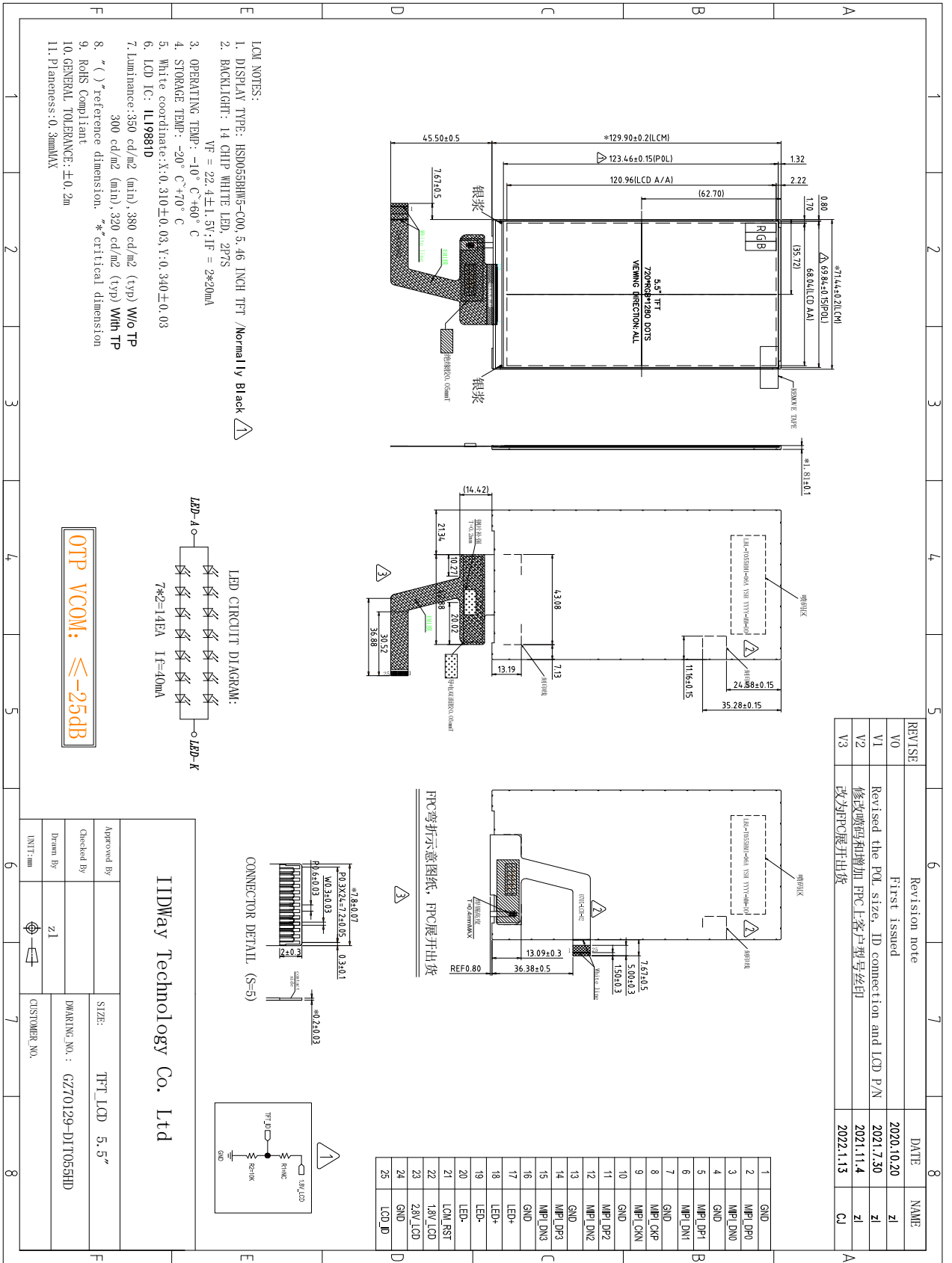

REVISE	Revision note	DATE	NAME
V0	First issued	2020.10.20	zl
V1	Revised the POL size, ID connection and LCD P/N	2021.7.30	zl
V2	修改二维码和增加 FPC上客户型号丝印	2021.11.4	zl
V3	改为FPC展开出货	2022.1.13	CJ

IIDWay Technology Co. Ltd	
Approved By	SIZE: TFT_LCD 5.5"
Checked By	DRAWING NO.: GZ70129-D1T055HD
Drawn By	ZL
UNIT:mm	CUSTOMER NO.

IIDWay Technology Co. Ltd

5. Absolute Maximum Ratings($T_a=25^\circ\text{C}$)

5.1 Electrical Absolute Maximum Ratings.($V_{SS}=0\text{V}$, $T_a=25^\circ\text{C}$)

Item	Symbol	Min.	Max.	Unit	Note
Power Supply Voltage	VDD	-0.3	6.6	V	1, 2
Logic Signal Input /Output Voltage	IOVCC	-0.3	3.6	V	1, 2

Notes:

1. If the module is above these absolute maximum ratings. It may become permanently damaged. Using the module within the following electrical characteristic conditions are also exceeded, the module will malfunction and cause poor reliability.

2. $V_{CC} > V_{SS}$ must be maintained.

5.2 Environmental Absolute Maximum Ratings.

Item	Storage		Operating		Note
	MIN.	MAX.	MIN.	MAX.	
Ambient Temperature	-20°C	70°C	-30°C	80°C	1,2
Humidity	-	-	-	-	3

1. The response time will become lower when operated at low temperature.

2. Background color changes slightly depending on ambient temperature.

The phenomenon is reversible.

3. $T_a \leq 40^\circ\text{C}$: 85%RH MAX.

$T_a > 40^\circ\text{C}$: Absolute humidity must be lower than the humidity of 85%RH at 40°C .

IIDWay Technology Co. Ltd

6. Electrical Specifications and Instruction Code

6.1 Electrical characteristics($V_{SS}=0V, T_a=25^\circ C$)

Parameter	Symbol	Condition	Min	Typ	Max	Unit	Note
Power supply	VDD	$T_a=25^\circ C$	2.5	2.8	6.6	V	
	IOVCC	$T_a=25^\circ C$	1.65	1.8	3.3		
Input voltage	'H'	V_{IH}	$VDD=3.3V$	0.7VDD	-	VDD	V
	'L'	V_{IL}	$VDD=3.3V$	-0.3	-	0.3VDD	V

6.2 LED backlight specification($V_{SS}=0V, T_a=25^\circ C$)

Item	Symbol	Condition	Min	Typ	Max	Unit	Note
Supply voltage	V_f	$I_f=40mA$	18.9	21	23.1	V	
Uniformity	ΔB_p	$I_f=40mA$	80	-	-	%	
Luminance for LCD(w/o TP)	L_v	$I_f=40mA$	-	380	-	Cd/m ²	

IIDWay Technology Co. Ltd

6.3 Interface signals

Pin No.	Symbol	I/O	Function
1	GND	P	Ground
2	MIPI_DP0	I	Positive polarity of low voltage differential data signal
3	MIPI_DN0	I	Negative polarity of low voltage differential data signal
4	GND	P	Ground
5	MIPI_DP1	I	Positive polarity of low voltage differential data signal
6	MIPI_DN1	I	Negative polarity of low voltage differential data signal
7	GND	P	Ground
8	MIPI_CKP	I	Positive polarity of low voltage differential clock sign
9	MIPI_CKN	I	Negative polarity of low voltage differential clock signal
10	GND	P	Ground
11	MIPI_DP2	I	Positive polarity of low voltage differential data signal
12	MIPI_DN2	I	Negative polarity of low voltage differential data signal
13	GND	P	Ground
14	MIPI_DP3	I	Positive polarity of low voltage differential data signal
15	MIPI_DN3	I	Negative polarity of low voltage differential data signal
16	GND	P	Ground
17	LED+	P	LED back light(Anode)
18			
19	LED-	P	LED back light(Cathode)
20			
21	LCM_RST	I	Reset the display
22	1.8_LCD	P	Digital IO Pad power supply
23	2.8_LCD	P	Power supply
24	GND	P	Ground
25	LCD_ID	O	ID PIN

IIDWay Technology Co. Ltd

6.4 MIPI AC Characteristics

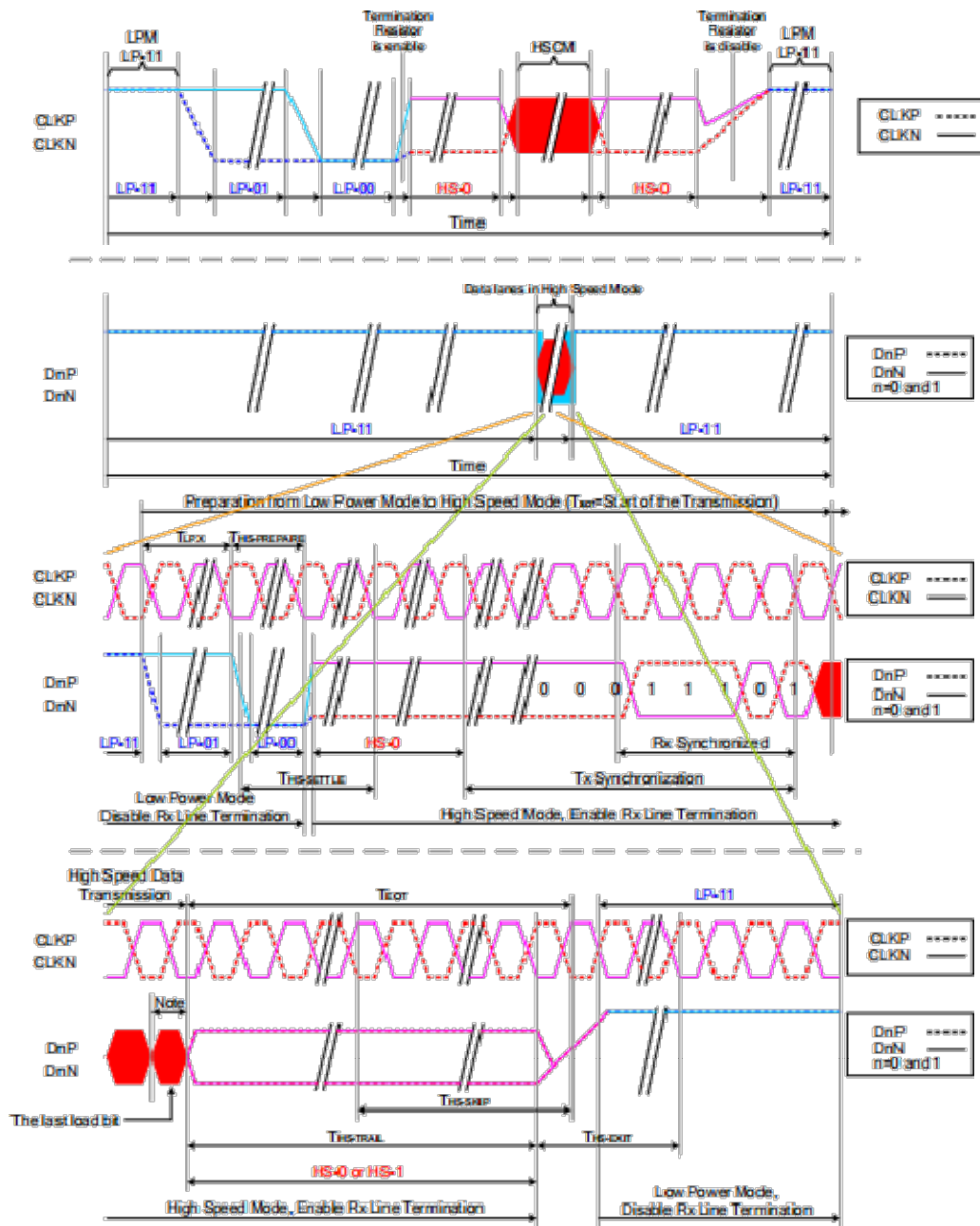

IIDWay Technology Co. Ltd

7. Optical Characteristics

Item	Symbol	Condition	Min.	Typ.	Max.	Unit	Note	
Brightness (With TP)	Bp	$\theta=0^\circ$ $\Phi=0^\circ$	-	380	-	Cd/m ²	1	
Uniformity	Δ Bp		75	-	-	%	1,2	
Viewing Angle	3:00	Cr \geq 10	-	80	-	Deg	6	
	6:00		-	80	-			
	9:00		-	80	-			
	12:00		-	80	-			
Contrast Ratio	Cr	$\theta=0^\circ$ $\Phi=0^\circ$	720	900	-	-	4	
Response Time	T _r		-	12	15	ms	5	
	T _f		-	20	25	ms		
Color of CIE Coordinate	W	x	$\theta=0^\circ$ $\Phi=0^\circ$	Typ- 0.05	TBD	Typ+ 0.05	-	7
		y					-	
	R	x					-	
		y					-	
	G	x					-	
		y					-	
	B	x					-	
		y					-	
NTSC Ratio	S		-	70	-	%		

Note: The parameter is slightly changed by temperature, driving voltage and materiel

Note 1: The data are measured after LEDs are turned on for 5 minutes. LCM displays full white. The brightness is the average value of 9 measured spots. Measurement equipment PR-705 (Φ 8mm)

Measuring condition:

- Measuring surroundings: Dark room.
- Measuring temperature: T_a=25 °C.
- Adjust operating voltage to get optimum contrast at the center of the display.

Measured value at the center point of LCD panel after more than 5 minutes while backlight turning on.

IIDWay Technology Co. Ltd

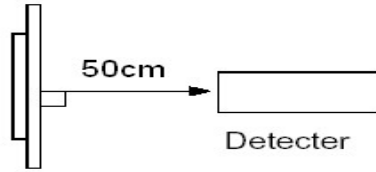

Note 2: The luminance uniformity is calculated by using following formula.

$$\Delta Bp = Bp (\text{Min.}) / Bp (\text{Max.}) \times 100 (\%)$$

$Bp (\text{Max.})$ = Maximum brightness in 9 measured spots

$Bp (\text{Min.})$ = Minimum brightness in 9 measured spots.

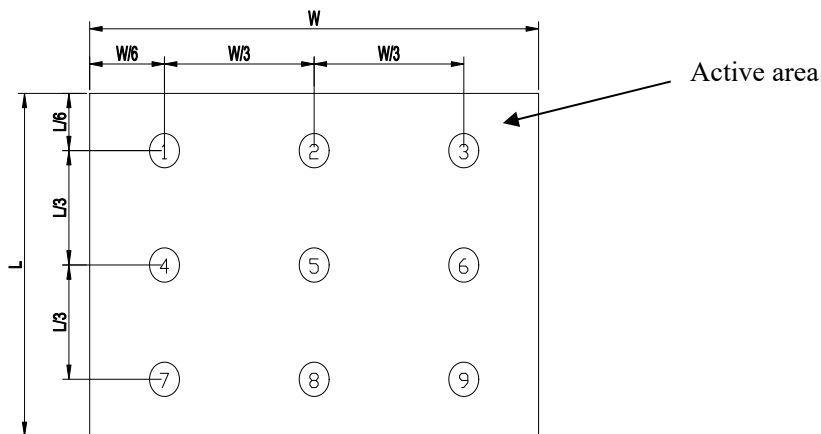

Note 3: The definition of viewing angle:

Refer to the graph below marked by ϑ and ϕ

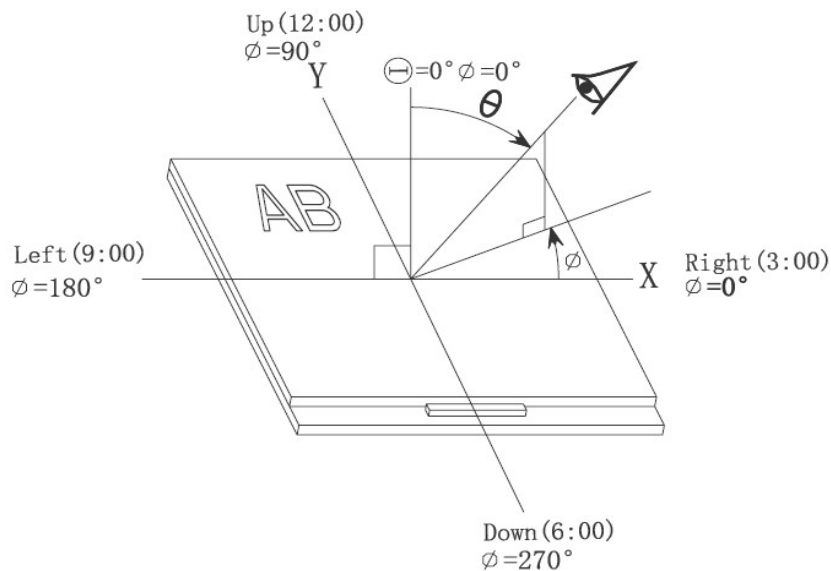

Note 4: Definition of contrast ratio.(Test LCD using DMS501)

IIDWay Technology Co. Ltd

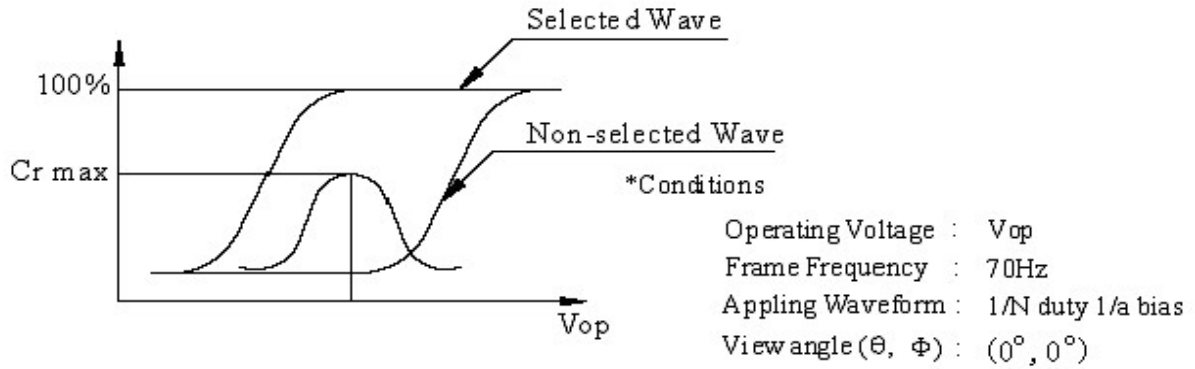

$$\text{Contrast ratio}(Cr) = \frac{\text{Brightness of selected dots}}{\text{Brightness of non-selected dots}}$$

Note 5: Definition of Response time. (Test LCD using DMS501):

The output signals of photo detector are measured when the input signals are changed from "black" to "white"(falling time) and from "white" to "black"(rising time), respectively. The response time is defined as the time interval between the 10% and 90% of amplitudes. Refer to figure as below.

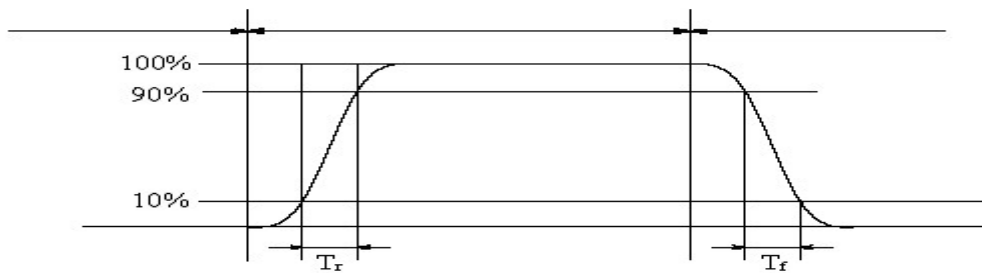

The definition of response time

Note 6: Definition of Color of CIE Coordinate and NTSC Ratio.

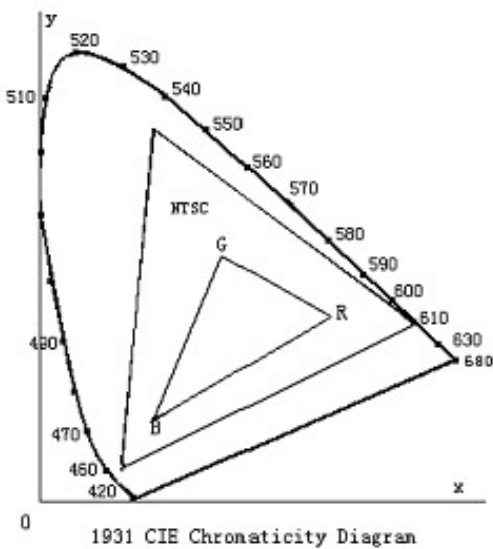

Color gamut:

$$S = \frac{\text{area of RGB triangle}}{\text{area of NTSC triangle}} \times 100\%$$

IIDWay Technology Co. Ltd

Note 7: Definition of cross talk.

*Cross talk ratio(%)=|pattern A Brightness-pattern B Brightness|/pattern A Brightness*100*

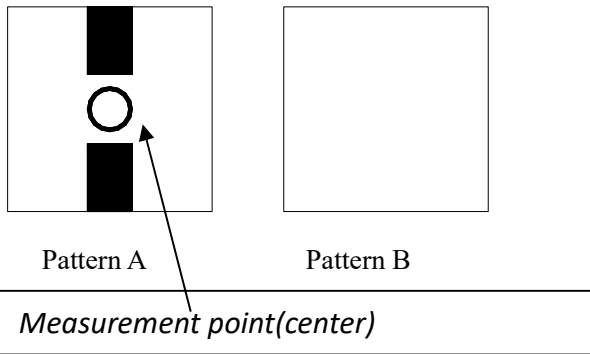

Electric volume value=3F+/-3Hex

IIDWay Technology Co. Ltd

8. Reliability Test Items and Criteria

No	Test Item	Test condition	Criterion
1	High Temperature Storage	80°C 96H Restore 2H at 25°C Power off`	1. After testing, cosmetic and electrical defects should not happen. 2. Total current consumption should not be more than twice of initial value.
2	Low Temperature Storage	-30°C 96H Restore 2H at 25°C Power off	
3	High Temperature Operation	70°C 96H Restore 2H at 25°C Power on	
4	Low Temperature Operation	-20°C 96H Restore 4H at 25°C Power on	
5	High Temperature/Humidity Operation	60°C±2°C 90%RH 96H Power on	
6	Temperature Cycle	--30°C ←-----→ 85°C 30min 5min 30min after 5 cycle, Restore 2H at 25°C Power off	

Note: Operation: Supply 2.8V for logic system.

The inspection terms after reliability test, as below

<i>ITEM</i>	<i>Inspection</i>
<i>Contrast</i>	<i>CR>50%</i>
<i>IDD</i>	<i>IDD<200%</i>
<i>Brightness</i>	<i>Brightness>60%</i>
<i>Color Tone</i>	<i>Color Tone+/-0,05</i>

IIDWay Technology Co. Ltd

9. Precautions for Use of LCD Modules

9.1 Handling Precautions

9.1.1 *The display panel is made of glass. Do not subject it to a mechanical shock by dropping it from a high place, etc.*

9.1.2 *If the display panel is damaged and the liquid crystal substance inside it leaks out, be sure not to get any in your mouth, if the substance comes into contact with your skin or clothes, promptly wash it off using soap and water.*

9.1.3 *Do not apply excessive force to the display surface or the adjoining areas since this may cause the color tone to vary.*

9.1.4 *The polarizer covering the display surface of the LCD module is soft and easily scratched. Handle this polarizer carefully.*

9.1.5 *If the display surface is contaminated, breathe on the surface and gently wipe it with a soft dry cloth. If still not completely clear, moisten cloth with one of the following solvents:*

— Isopropyl alcohol — Ethyl alcohol

Solvents other than those mentioned above may damage the polarizer. Especially, do not use the following:

— Water — Ketone — Aromatic solvents

9.1.6 *Do not attempt to disassemble the LCD Module.*

9.1.7 *If the logic circuit power is off, do not apply the input signals.*

9.1.8 *To prevent destruction of the elements by static electricity, be careful to maintain an optimum work environment.*

a. Be sure to ground the body when handling the LCD Modules.

b. Tools required for assembly, such as soldering irons, must be properly ground.

c. To reduce the amount of static electricity generated, do not conduct assembly and other work under dry conditions.

d. The LCD Module is coated with a film to protect the display surface. Be care when peeling off this protective film since static electricity may be generated.

9.2 Storage precautions

9.2.1 *When storing the LCD modules, avoid exposure to direct sunlight or to the light of fluorescent*

IIDWay Technology Co. Ltd

lamps.

9.2.2 The LCD modules should be stored under the storage temperature range. If the LCD modules will be stored for a long time, the recommend condition is:

Temperature : 0°C ~ 40°C

Relatively humidity: ≤80%

9.2.3 The LCD modules should be stored in the room without acid, alkali and harmful gas.

9.3 The LCD modules should be no falling and violent shocking during transportation, and also should avoid excessive press, water, damp and sunshine.

END
